

URBAN FIRE -2-

Propane / Natural Gas Outdoor Gas Fireplace

Installation and Operating Instructions



WARNING: For Outdoor Use Only.

Certified by the CSA
(Canadian Standards Association)
CSA 4.96 U.S. (3rd Ed.),
Outdoor Gas Fireplace
CGA CR97-003



WARNING: If the information in this manual is not followed exactly, a fire or explosion may result causing property damage, personal injury, or loss of life.

For your safety

Do not store or use gasoline or other flammable vapors and liquids in the vicinity of this or any other appliance.

What to do if you smell gas

- Do not try to light any appliance.
- Do not touch any electrical switch; do not use any phone in your building.
- Immediately call your gas supplier from a neighbor's phone. Follow the gas supplier's instructions.
- If you cannot reach your gas supplier, call the fire department.

Installation and service must be performed by a qualified installer, service agency or the gas supplier.

WARNING: Improper installation, adjustment, alteration, service or maintenance can cause injury or property damage. Read the installation, operating and maintenance instructions thoroughly before installing or servicing this equipment.

Retain this manual for future reference

Table of Contents

INTRODUCTION	
Specifications.....	3
Dimensions & Installation Codes.....	4
General Safety.....	5
 OPERATION	
Lighting Instructions	6
LP Gas Safety Information	7
LP Gas Cylinder Connection.....	8
Leak Testing	9
 INSTALLATION	
Installation & Safety Notes	10
Initial Firing	11
Minimum Clearances	11
Installation and Tank Assembly	12
Glass Placement	13
Natural Gas Conversion.....	14 & 15
 MAINTENANCE	
Maintenance Safety	16
Recommended Service	16
Burner Cleaning	16
Trouble Shooting	17
Replacement Parts	18
Warranty	19 & 20

Urban Fire Corp.
103 South Belair Drive
Woodbridge, Ontario,
L4H 2N4
Canada 1-888-337-4989

1.0 INTRODUCTION

1.1 SPECIFICATIONS

TABLE 1

ITEM	PROPANE (LPG)	NATURAL GAS
INPUT: Hi	60,000 Btu/h (17.60kW)	60,000 Btu/h (17.60 kW)
INPUT: Lo	30,000 Btu/hr (8.79 kW)	30,000 Btu/hr (8.79 kW)
MAXIMUM GAS INLET SUPPLY PRESSURE:	Minimum LPG 11" w.c. (2.74 kPa)	Minimum NG 7" w.c (1.744 kPa)
AIR SHUTTER SETTING	Adjustable from fully closed to fully open	Recommended adjustment to fully closed
ORIFICE SIZE: @ 0-2000'	# 42 LPG	#30 NG
Clearances to combustibles Sides: Floor: Ceiling:	36" (91.44 cm) 0* 72" (183 cm)	36" (91.44 cm) 0* 72" (183 cm)

* Urban Fire -2- can be placed on a combustible base.

APPLIANCE

DIMENSIONS

Figure 1

URBAN FIRE -2-



36" W x 36" L x 16.5" H

INSTALLATION CODES

Installation must conform to local codes or in the absence of local codes, installation must conform to the *National Fuel Gas Code, ANSI Z233. 1*, or the current *CAN/CGA B149.05 Installation Codes*. In the state of Massachusetts, this product can only be installed by a licensed plumber or a licensed gas fitter. Failure to comply will void the warranty.

The appliance and its individual shutoff valve must be disconnected from the gas supply piping system during any pressure testing of that system at test pressures in excess of $1/2$ psi (3.5 kPa).

The appliance must be isolated from the gas supply piping system by closing its individual manual shutoff valve during any pressure testing of the gas supply piping system at test pressures equal to or less than $1/2$ psi (3.5 kPa).

GENERAL SAFETY

- Solid fuels shall not be burned in this fireplace.
- Keep the appliance area clear and free from combustible materials, gasoline and other flammable vapors and liquids.
- Inspect the burner prior to each use, if the burner is damaged it must be replaced prior to use.
NOTE: Use only with burner part# UFP 1-02-1
- Inspect the pilot prior to each use, if the pilot is damaged, plugged or does not light, replace damaged components prior to use.
- Do not use this appliance if any part has been under water. Immediately call a qualified service technician to inspect the appliance and to replace any part of the control system and any gas control which has been under water.
- Do not locate the gas supply hose in a pathway where people may trip over it or in areas where the hose may be subjected to accidental damage.

- **Children and adults should be alerted to the hazards of high surface temperature and should stay away to avoid burns or clothing ignition.**
- **Young children should be carefully supervised when they are in the area of the appliance. Keep cover of the fireplace secured on the appliance when not in use to prevent children from playing, touching or eating the tempered glass.**
- **Clothing or other flammable material should not be hung from the appliance or placed near the appliance.**
- **Any guard or other protective device removed for servicing the appliance must be replaced prior to operating the appliance.**
- **Installation and repair should be done by a qualified service person. The appliance should be inspected before use and at least annually by a qualified service person. More frequent cleaning may be required as necessary. It is imperative that control compartments, burners and circulating air passageways of the appliance be kept clean.**

LIGHTING INSTRUCTIONS

Safety Information - Read Before Lighting

Warning: If you do not follow these instructions exactly, a fire or explosion may result causing property damage, personal injury or loss of life.

Ensure that the screen is clear of glass and completely unobstructed before lighting.

BEFORE LIGHTING, smell all around the fireplace area for gas. Be sure to smell next to the ground because some gas is heavier than air and will settle downwards.

If you smell gas, follow the instructions on connecting the gcc valve to the tank in section 3.1 and repeat soap test for leaks.

Use only your hand to push in or turn the gas control knob. Never use tools. If the knob will not push in or turn by hand, **DO NOT** try to repair it. Call a qualified professional service technician. Force or attempted repair may result in fire or explosion.

1. Open propane tank valve - OR - Natural Gas supply line, to supply gas to appliance.
2. Check all connections for leaks (see page 9 for instructions on leak testing).
3. Rotate the control knob to 12 o'clock to locate pilot. Depress control knob to release gas to the pilot. While depressing the control knob, press the igniter button with the other hand, listen for a clicking sound and watch for ignition flame in pilot box.
4. With Pilot flame visible - hold in control knob for 30 seconds to heat up thermo couple. Pilot light will stay lit. Release pressure on control knob.
5. Slowly turn control knob towards 9 o'clock for desired flame height (see image below)

Note: Allow time for gas to flow through hose while pressing piezo igniter (10 seconds max). If no flame appears, turn the control knob off, wait 5 minutes, and repeat steps 1 - 3.



WARNING: Cover must be removed when burner is in operation.

This appliance is equipped with a battery operated electric ignitor. Be aware and look for proof of ignition spark. If there is no ignition spark replace battery or light pilot

IMPORTANT SAFETY INFORMATION

ABOUT PROPANE (LP) GAS

The LP-gas cylinder used with this appliance must be equipped with a Type 1 QCC connection and an OPD (overfill protection device).

The LP-gas supply cylinder to be used must be constructed and marked in accordance with the specifications for LP-gas cylinders of the U.S. Department of Transportation (DOT) or Transport Canada, CAN/CSA-B339, Cylinders, Spheres and Tubes for the Transportation of Dangerous Goods.

The cylinder supply system must be arranged for vapour withdrawal.

The cylinder used must include a collar to protect the cylinder valve.

This appliance shall be used only outdoors in a well-ventilated space and shall not be used in a building, garage, or any other enclosed space.

When this appliance is not in use, the gas must be turned off at the supply cylinder.

Storage of this appliance indoors is permissible only if the cylinder is disconnected and removed from the appliance.

Cylinders must be stored outdoors out of the reach of children and must not be stored in a building, garage or any other enclosed areas.

Inspect the hose assembly for damage prior to each use. If the hose is damaged or there are signs of excessive abrasion or wear replace the hose.

Use only the pressure regulator and hose assembly supplied with the appliance. Replace the regulator hose assembly only with part number UFP LP12-08 these are available only from approved dealer -OR- Urban Fire.

The specific size of cylinder(s) to be used with this gas fireplace is recommended not to be below or exceed 20 lbs. (9 kg) capacity. Ensure cylinder is secured, upright, on a level non-combustible base.

If a larger TC or DOT cylinder is to be used. Ensure that the cylinder is safely secured, upright on a non-combustible base, located a minimum of 10ft from the fireplace and in a ventilated space.

Do not place a propane cylinder for use with this appliance on a non-combustible base - even snow. Snow around the base of the cylinder foot ring could melt and the cylinder could fall over delivering liquid propane to the unit.

Do not connect, activate or disconnect this fireplace to a propane cylinder anytime while consuming alcohol. Failure to do so could result in fire causing bodily harm or loss of life.

LP GAS CYLINDER CONNECTION

Before attaching the hose pressure regulator to the tank, be sure that the cylinder valve and appliance valves are OFF.

The QCC1 cylinder valve has an internal back check module which will not allow gas to flow until a connection has been made.

The valve is turned off by rotating the handwheel clockwise (left to right) until it stops.

When attaching the pressure regulator to the tank, make sure that the small probe (figure 1) in the nipple is centered in the mating QCC1 cylinder valve, turn the right hand threaded QCC1 nut onto the valve in a clockwise motion until there is a positive stop. DO NOT USE A WRENCH. HAND-TIGHTEN ONLY!

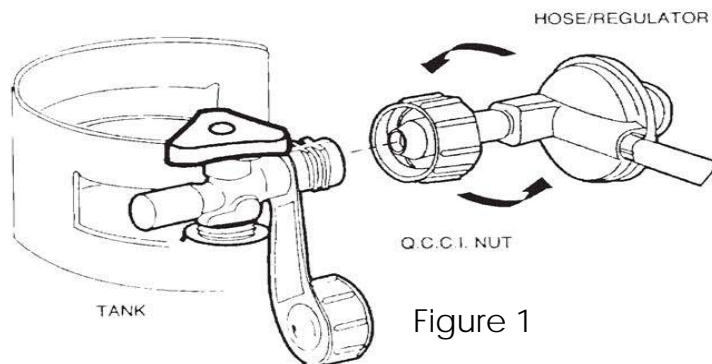

Figure 1

The LP cylinder must include a collar to protect the cylinder valve.

The cylinder supply system must be arranged for vapor withdrawal. This appliance uses a "Type 1" cylinder connection device. See above for proper connection instructions.

When disconnecting and removing the gas cylinder, from the appliance, always be sure to adhere to the following items:

- Check that the gas control valve on the appliance, as well as on the cylinder are turned off before disconnecting the gas line from the cylinder.
- Never smoke or have an open flame in the vicinity of the gas appliance or gas cylinder.
- When connection a new gas supply cylinder, be sure to tighten all connections and leak test the connections with a soapy water solution.

How to Leak Test Your Appliance

- Mix a solution of liquid soap and water in a small container. 50% soap and 50% water.
- Make sure that the gas supply is turned on. For LP gas appliances make sure that the valve on the gas cylinder is turned on.
- Ensure that the gas control valve on the appliance is in the “OFF” position. (3 o’clock).
- Use a spray bottle or a small brush and liberally apply the solution to the gas line and to each connection.
- If bubbles form this means that there is a leak is present.
- Tighten any connections that may be loose and leak test again.
- If no more leaks are found use the appliance.
- If leaks persist and cannot be stopped turn off the gas supply and contact your distributor or local gas service technician for assistance.
- To check for leaks on the hose, soak cloth with soap and water solution. Rub gas line hose from end to end. If bubbles appear, identify leak and replace hose before next use.
- **WARNING: Do not use an open flame to test for gas leaks.**

BATTERY & GLASS INSTALLATION

BATTERY INSTRUCTIONS:

INSERT AAA BATTERY INTO IGNITER BY UN-SCREWING, BY HAND, COUNTER CLOCKWISE THE CONTROL BUTTON. INSERT BATTERY (NOTE DIRECTION IS CRITICAL AND IMPRINTED ON THE INNER IGNITOR). POSITIVE (MALE END) SHOULD FACE YOU. SCREW BACK ON CONTROL BOTTON AND DEPRESS.

YOU WILL HEAR A SPARK AT THE PILOT.

IF YOU DO NOT HEAR A SPARK;

- A) CHECK IF BATTERY DIRECTION IS REVERSED.
- B) CHECK AND ENSURE BATTERY STRENGTH.
- C) CHECK WIRE ON BACK OF IGNITER (ORANGE WIRE) IS ATTACHED AT BACK OF IGNITER.

URBAN FIRE GLASS:

NOTE: ENSURE TO SPREAD GLASS OVER THE BURNER AND INNER RING. YOU SHOULD NOT SEE THE BURNER OR INNER RING.

ENSURE GLASS IS AWAY FROM PILOT COVER SO THE PILOT CAN BREATHE.

NOTE: OTHER COLOURS ARE AVAILABLE TO MATCH YOUR DÉCOR. PLEASE VISIT WWW.URBANFIRE.CA TO SEE ALL COLOURS AVAILABLE. YOU WILL REQUIRE 25LBS OF GLASS TO CHANGE YOUR COLOUR OF YOUR FIREPLACE GLASS.

INSTALLATION & SAFETY NOTES

Read all instructions before starting installation and follow them carefully during installation to ensure maximum benefit and safety. Failure to follow these instructions will void your warranty and may present a fire hazard. See the warranty at the back of this manual for disclaimers regarding improper installation. This outdoor fireplace and its components are tested and safe when installed in accordance with this installation manual.

UNPACKING

Please check the appliance carefully for any damaged or missing components. Report any problems to your dealer within 30 days of purchase.

MINIMUM CLEARANCES

The minimum clearance to combustibles for the sides and the top is 36" (914 mm). This outdoor fireplace is suitable for installation on a combustible surface.

Clearances are in accordance with local installation codes and the requirements of the gas supplier.

INITIAL FIRING

When lit for the first time, the appliance may emit an odor resulting from evaporation of paint and lubricants used in the manufacturing process. This is normal and will subside after the unit has run for an hour or so.

MANIFOLD PRESSURE REGULATOR ADJUSTMENT

The manifold pressure regulator controls gas input and flame height, and is pre-adjusted at the factory. No further adjustment is required.

PRIMARY AIR ADJUSTMENT

Aeration is factory set but may need adjustment for altitude or movement during shipping. The adjustment for the air shutter is found on the mixing tube which is located underneath your appliance. Loosen the screw which holds the aeration adjustment shutter in place and rotate the adjustment shutter to increase or decrease primary air (see below) and tighten the screw. Increasing the primary air will cause the flame to appear more transparent and blue. Decreasing the primary air will cause the flames to appear more yellow or orange. Evaluate the aeration only after the unit has warmed up approximately 15 minutes. If the unit shows signs of carbon build up increasing the primary air should alleviate this problem.

Caution: Parts requiring adjustment during operation may be hot.

Aeration adjustment is important for the correct functioning of the appliance. Carbon build up, flame lifting or any malfunction due to improper aeration adjustment during installation is not covered under the factory warranty.

INSTALLATION & TANK ASSEMBLY



NOTE: THIS IMAGE IS FOR SAFETY PURPOSES ONLY TO SHOW THE HOSE LENGTH, TANK RETENTION DEVICE AND RECOMMENDED PROPANE TANK SIZE FOR PROPANE INSTALLATIONS.

When using propane and for décor purposes we recommend feeding the gas hose under an outdoor carpet to hide the propane hose and reduce any tripping on the gas line.

To hide the tank, place the propane tank in the retention device and place behind a couch or side table. For longer operation time on propane for serious users, we recommend a 30lb or 40lb propane tank.

- Carefully unpack all the items from the box. Urban Fire comes fully assembled.
- Place the table outside in final position. There must be a minimum of 12 inches of clearance from the bowl to any combustibles. The table and bowl should not get hot. NOTE: For your safety, do not touch the fire glass that has had flame impingement. You will get a serious burn.
- Place the table on a level base.
- When using propane place cylinder upright inside the tank holder supplied. (SEE ABOVE) Tank should be secure and pressed into the tank holder for safety.
- Ensure propane gas hose and tank is positioned away from foot traffic.

GLASS PLACEMENT

Note: We recommend that before you install the crushed tempered glass, you familiarize yourself with the burner assembly. This will help you be confident operating the appliance when fully installed with glass.

Make sure the glass does not cover the screen. Keep glass off the screen box.

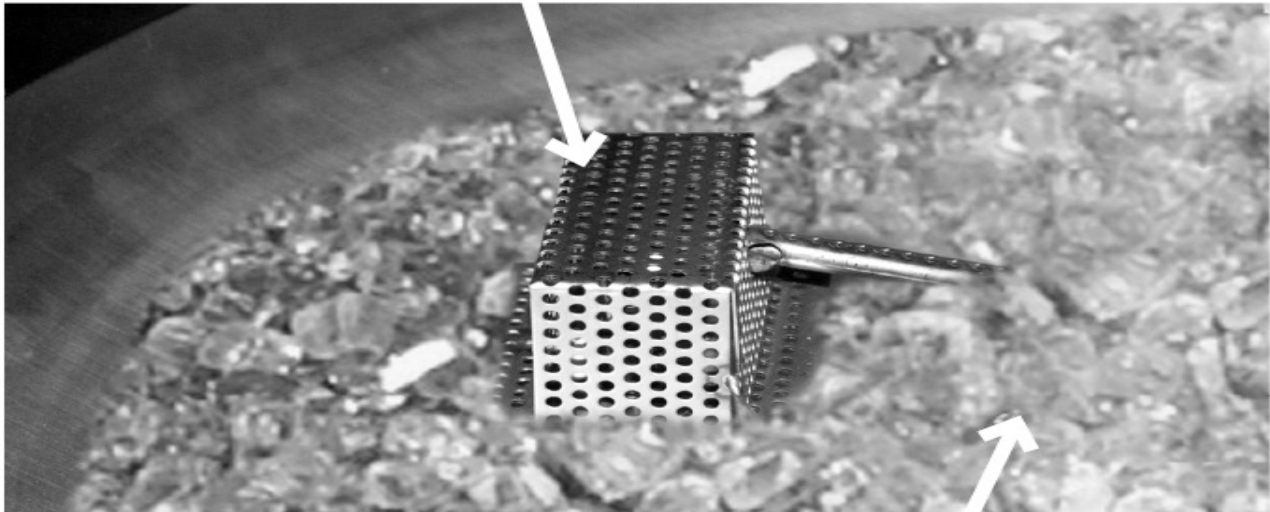

Urban Fire rated tempered glass is safe to handle and will retain its shape, colour and safety features.

1. Pour the Urban Fire rated glass in the center of the bowl on top of the burner. Spread the glass evenly in the bowl. Ensure that the glass does NOT cover the pilot assembly. Any glass near the pilot assembly is required to be moved away to allow fresh air to mix with the pilot flame.

Ensure that the glass does NOT cover the pilot assembly. Any glass near the pilot assembly is required to be moved away to allow fresh air to mix with the pilot flame.

NATURAL GAS CONVERSION

To convert this appliance for use with Natural Gas, follow steps A, B and C exactly (refer to images) - OR - contact a qualified Natural Gas service professional to do the installation.

a. Hose



1. Using two adjustable wrenches disconnect propane hose, 3/8 flare fitting and propane pilot regulator as shown above. Using gas pipe compound, attach Natural Gas pilot regulator and 3/8 flare fitting.



2. Attach the Natural Gas hose to swivel (Natural Gas hose not included, purchase at local retailer).

b. Orifice

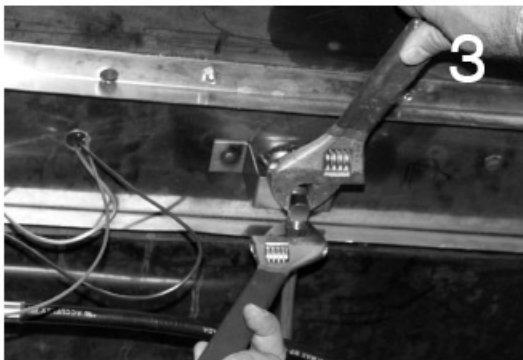

3. Underneath the unit, unscrew the brass nut holding the orifice.

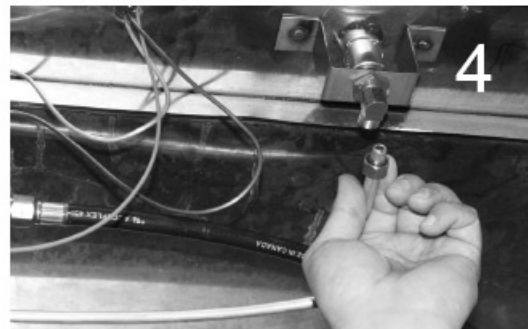

4. Remove orifice by removing support nut attached to bracket.



5. Remove LPG orifice tip and replace with NG (larger opening) orifice tip.

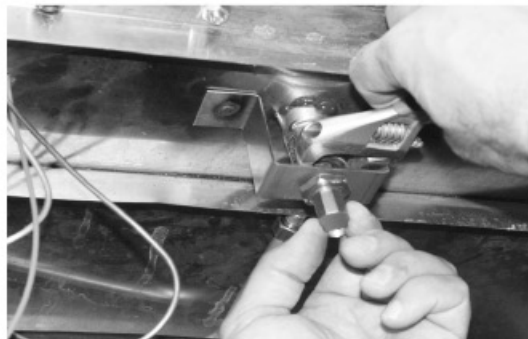

6. Reattach converted orifice to supporting bracket with nut. Leak check with a soap and water solution.

WARNING

These instructions must be followed exactly. Not doing so may result in personal and/or property damage.

c. Pilot

7. Take protective cover box off of the pilot assembly by removing the mounting screws located on the top side of the pilot assembly. This will allow you to access the pilot assembly. Take an adjustable wrench and loosen the pilot flame counter clockwise. This will allow you access to the pilots' orifice.

8. Slide tab to Natural Gas position (slightly larger hole). Re-fasten pilot flame with wrench clockwise. Soap check.

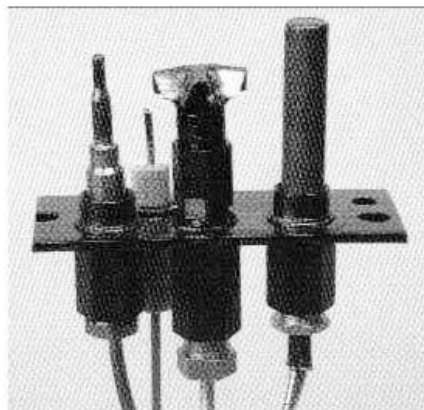

Tab in L.P
Gas Position

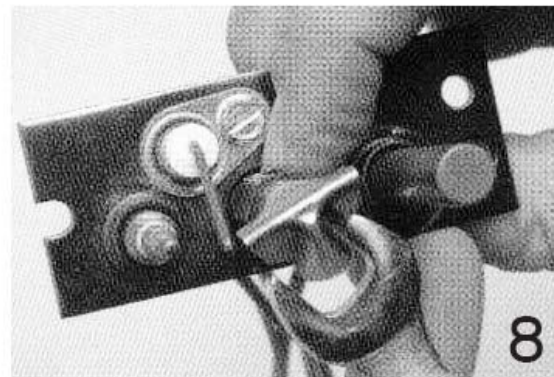
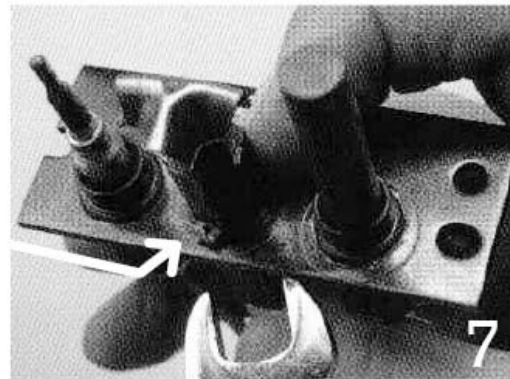

Tab in Natural
Gas Position

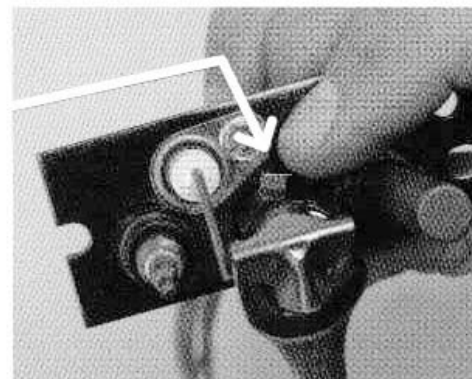

MAINTENANCE

MAINTENANCE SAFETY

Turn off the gas to the main burner and allow the fireplace to cool for 30 minutes before servicing.

Service and repair should be done by a qualified service person. The appliance should be inspected before use and at least annually by a qualified service technician. It is important that the access door compartment and burner be kept clean to provide for adequate combustion and ventilation airflow. Do not substitute materials or use components other than factory supplied.

RECOMMENDED SERVICE

Visually check the burner flame occasionally.

Have the appliance inspected annually by a professional service technician.

Clean the appliance regularly.

.

TROUBLE SHOOTING

SYMPTOM	POSSIBLE CAUSE	CORRECTIVE ACTION	
Pilot will not light after repeated triggering of the ignition button	1. No Spark at Pilot	1. Ensure AAA Battery is inserted correctly. Ensure AAA Battery has power.	
	2. Poor connections at ignition electrode	2. Reconnect ORANGE wire at the back of the igniter it may be off or loose	
	3. Broken ceramic cover on ignition electrode	3. Replace pilot assembly	
	4. Pilot wont light	4. Remove glass around pilot cover	
	5. Defective igniter	5. Replace igniter	
	6. Blocked Pilot - cannot hear gas	6. Clean dirt or rust from pilot –or- replace pilot	
	7. Whistle noise from pilot	7. Ensure pilot is converted to correct gas.	
	8. Unit shuts off sporadically after hearing a CLICK noise	8. Loosen (copper) thermocouple line and retighten hand tight with ¼ turn	
	B. No gas or low gas pressure		
	1. Gas line shut off	1. Turn on shut-off valves	
	2. Air in gas lines	2. Purge gas lines	
	3. Gas lines may not be connected	3. Connect all gas lines	
	4. Low pressure may be caused by bent line	4. Check for a kinked line	
	Burner will not light	A. Valve / Switches	
		1. Valve control off	1. Turn to "ON" position
2. Blockage at the burner (line, orifice, or ports)		2. Check and clean	

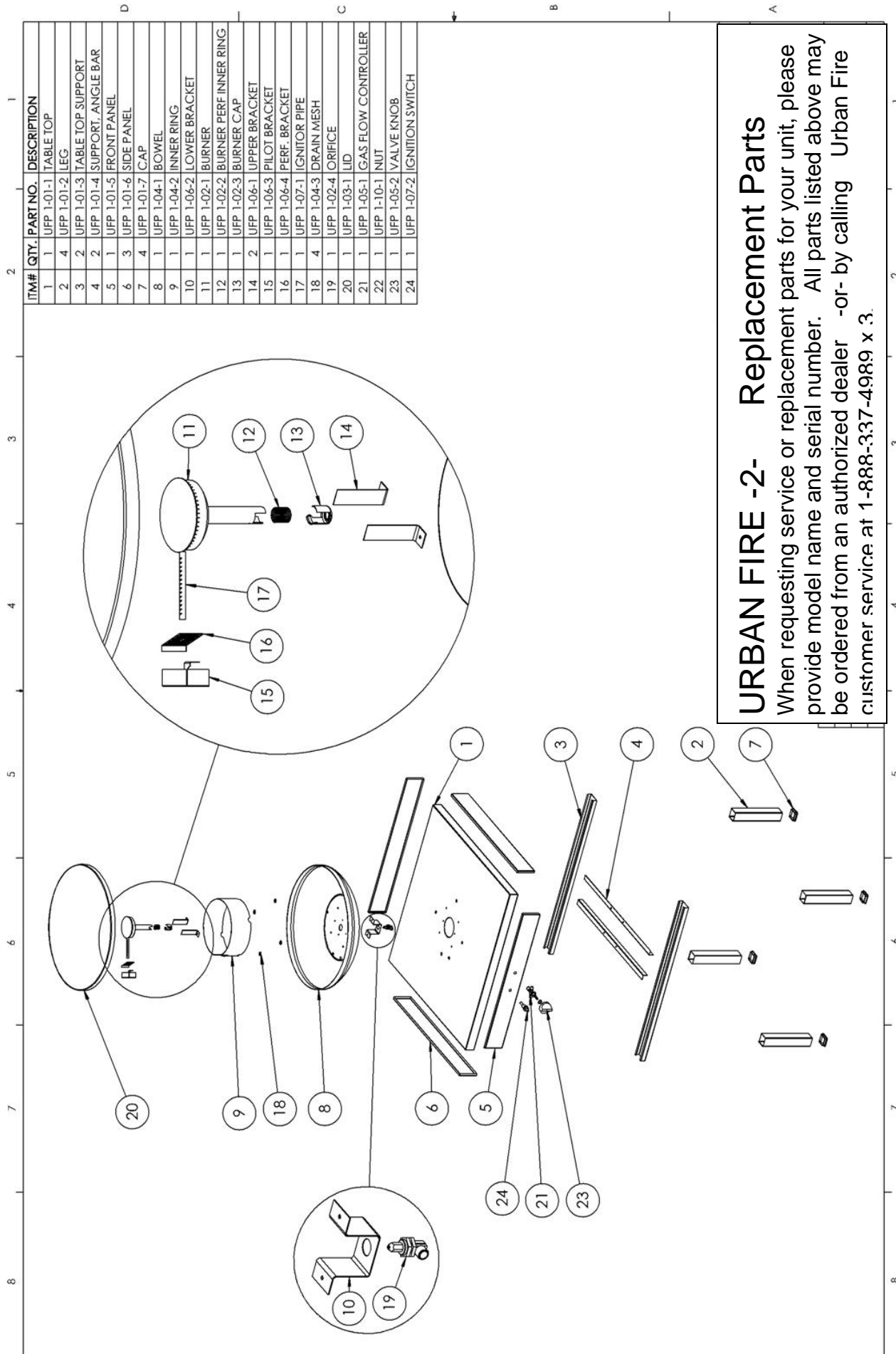

ITEM#	QTY.	PART NO.	DESCRIPTION
1	1	UFF 1-01-1	TABLE TOP
2	4	UFF 1-01-2	LEG
3	2	UFF 1-01-3	TABLE TOP SUPPORT
4	2	UFF 1-01-4	SUPPORT ANGLE BAR
5	1	UFF 1-01-5	FRONT PANEL
6	3	UFF 1-01-6	SIDE PANEL
7	4	UFF 1-01-7	CAP
8	1	UFF 1-04-1	BOWEL
9	1	UFF 1-04-2	INNER RING
10	1	UFF 1-04-2	LOWER BRACKET
11	1	UFF 1-02-1	BURNER
12	1	UFF 1-02-2	BURNER PERF INNER RING
13	1	UFF 1-02-3	BURNER CAP
14	2	UFF 1-06-1	UPPER BRACKET
15	1	UFF 1-06-3	PILOT BRACKET
16	1	UFF 1-06-4	PERF. BRACKET
17	1	UFF 1-07-1	IGNITOR PIPE
18	4	UFF 1-04-3	DRAIN MESH
19	1	UFF 1-02-4	ORIFICE
20	1	UFF 1-03-1	LID
21	1	UFF 1-05-1	GAS FLOW CONTROLLER
22	1	UFF 1-10-1	NUT
23	1	UFF 1-05-2	VALVE KNOB
24	1	UFF 1-07-2	IGNITION SWITCH

URBAN FIRE -2- Replacement Parts
 When requesting service or replacement parts for your unit, please provide model name and serial number. All parts listed above may be ordered from an authorized dealer -or- by calling Urban Fire customer service at 1-888-337-4989 x 3.

WARRANTY INFORMATION

Product Registration

Please register your product immediately at www.urbanfire.ca or call 1-888-337-4989 x 3

Limited Warranty

Urban Fire co. warrants to the original retail purchaser of this outdoor fireplace, and to no other person, that if this outdoor fireplace is assembled and operated in accordance with the printed instructions accompanying it, then for a period of ninety (90) days from the date of purchase, all parts in such outdoor fireplace shall be free from defects in material and workmanship. Vendor may require reasonable proof of your date of purchase. Therefore, you should retain your sales slip or invoice. This Limited Warranty shall be limited to the repair or replacement of parts which

prove defective under normal use and service and which Vendor shall determine in its reasonable discretion upon examination to be defective. Before returning any parts, you should contact Vendor's Customer Service Department using the contact information listed below. If Vendor confirms, after examination, a defect covered by this Limited Warranty in any returned part, and if Vendor approves the claim, Vendor will replace such defective part without charge. If you return defective parts, transportation charges must be prepaid by you. Vendor will return replacement parts to the original retail purchaser, freight or postage prepaid.

This Limited Warranty does not cover any failures or operating difficulties due to accident, abuse, misuse, alteration, misapplication, improper installation or improper maintenance or service by you or any third party, or failure to perform normal and routine maintenance on the outdoor fireplace, as set out in the owner's manual.

This Limited Warranty is in lieu of all other express warranties. Vendor disclaims all warranties for products that are purchased from sellers other than authorized retailers or distributors, including the warranty of merchantability or the warranty of fitness for a particular purpose. VENDOR ALSO DISCLAIMS ANY AND ALL IMPLIED WARRANTIES, INCLUDING, WITHOUT LIMITATION, THE IMPLIED WARRANTIES OF MERCHANTABILITY AND FITNESS FOR A PARTICULAR PURPOSE. VENDOR SHALL ASSUME NO LIABILITY TO PURCHASER OR ANY THIRD PARTY FOR ANY SPECIAL, INDIRECT, PUNITIVE, INCIDENTAL, OR CONSEQUENTIAL DAMAGES. Vendor further disclaims any implied or express warranty of, and assumes no responsibility for, defects in workmanship caused by third parties. This Limited Warranty gives the purchaser specific legal rights; a purchaser may have other rights

depending upon where he or she lives. Some jurisdictions do not allow the exclusion or limitation of special, incidental or consequential damages, or limitations on how long a warranty lasts, so the above exclusion and limitations may not apply to everyone.

Vendor does not authorize any person or company to assume for it any other obligation or liability in connection with the sale, installation, use, removal, return, or replacement of its equipment, and no such representations are binding on Vendor.



Urban Fire Corp.
103 South Belair Drive,
Woodbridge,
Ontario Canada L4H 2N4

CUSTOMER SUPPORT:
1-888-337-4989, PRESS #3